

BASIC ELECTRONIC COMPONENTS

MODEL ECK-10

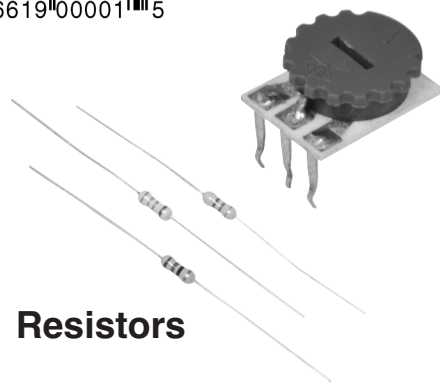

Resistors

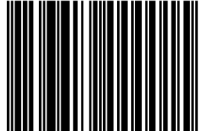
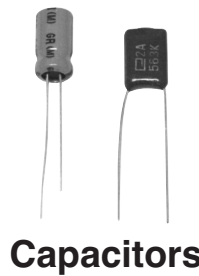

Capacitors



Coils



Others

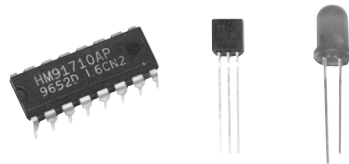

Semiconductors

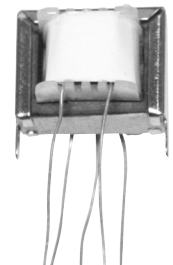

**Transformers
(not included)**

Instruction Manual *by Arthur F. Seymour MSEE*

It is the intention of this course to teach the fundamental operation of basic electronic components by comparison to drawings of equivalent mechanical parts. It must be understood that the mechanical circuits would operate much slower than their electronic counterparts and one-to-one correlation can never be achieved. The comparisons will, however, give an insight to each of the fundamental electronic components used in every electronic product.

ELENCO®

RESISTORS

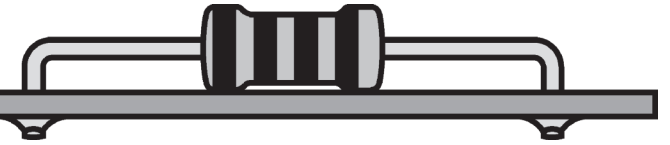

RESISTORS, *What do they do?*

The electronic component known as the resistor is best described as electrical friction. Pretend, for a moment, that electricity travels through hollow pipes like water. Assume two pipes are filled with water and one pipe has very rough walls. It would be easy to say that it is more difficult to push the water through the rough-walled pipe than through a pipe with smooth walls. The pipe with rough walls could be described as having more resistance to movement than the smooth one.

Pioneers in the field of electronics thought electricity was some type of invisible fluid that could flow through certain materials easily, but had difficulty flowing through other materials. In a way they were correct since the movement of electrons through a material cannot be seen by the human eye, even with the best microscopes made. There is a similarity between the movement of electrons in wires and the movement of water in the pipes. For example, if the pressure on one end of a water pipe is increased, the amount of water that will pass through the pipe will also increase. The pressure on the other end of the pipe will be indirectly related to the resistance the pipe has to the flow of water. In other words, the pressure at the other end of the pipe will decrease if the resistance of the pipe increases. Figure 1 shows this relationship graphically.

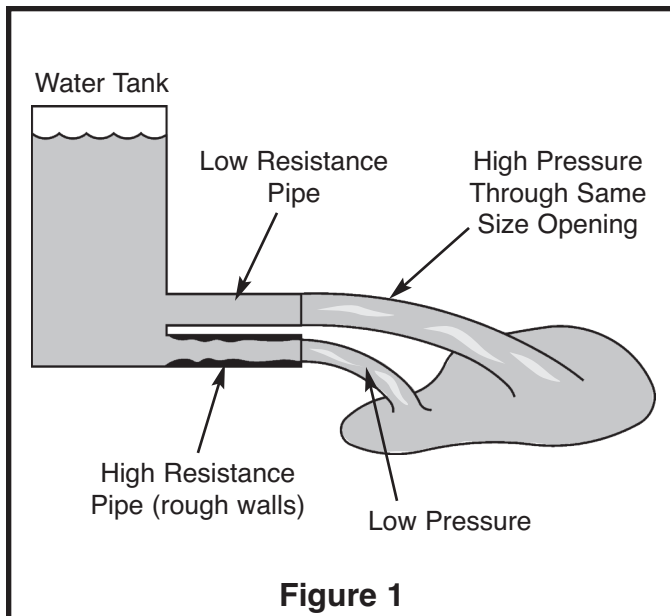

Figure 1

Electrons flow through materials when a pressure (called voltage in electronics) is placed on one end of the material forcing the electrons to “react” with each other until the ones on the other end of the material move out. Some materials hold on to their electrons more than others making it more difficult for the electrons to move. These materials have a higher resistance to the flow of electricity (called current in electronics) than the ones that allow electrons to move easily. Therefore, early experimenters called the materials *insulators* if they had very high resistance to electron flow and *conductors* if they had very little resistance to electron flow. Later materials that offered a medium amount of resistance were classified as *semiconductors*.

When a person designs a circuit in electronics, it is often necessary to limit the amount of electrons or current that will move through that circuit each second. This is similar to the way a faucet limits the amount of water that will enter a glass each second. It would be very difficult to fill a glass without breaking it if the faucet had only two states, wide open or off. By using the proper value of resistance in an electronic circuit designers can limit the pressure placed on a device and thus prevent it from being damaged or destroyed.

SUMMARY: The resistor is an electronic component that has electrical friction. This friction opposes the flow of electrons and thus reduces the voltage (pressure) placed on other electronic components by restricting the amount of current that can pass through it.

RESISTORS

RESISTORS, *How are they made?*

There are many different types of resistors used in electronics. Each type is made from different materials. Resistors are also made to handle different amounts of electrical power. Some resistors may change their value when voltages are placed across them. These are called voltage dependent resistors or *nonlinear* resistors. Most resistors are designed to change their value when the temperature of the resistor changes. Some resistors are also made with a control attached that allows the user to mechanically change the resistance. These are called variable resistors or potentiometers. Figure 2 shows physical shapes of some different types of resistors.

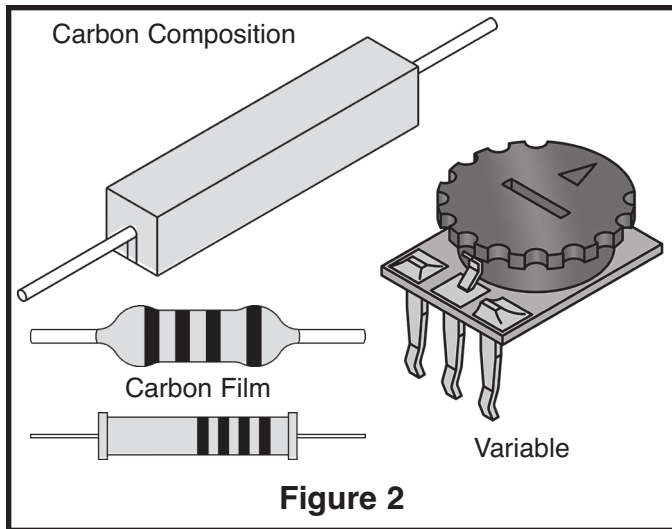

Figure 2

THE WIREWOUND RESISTOR

The first commercial resistors made were formed by wrapping a resistive wire around a non-conducting rod (see Figure 3). The rod was usually made of some form of ceramic that had the desired heat properties since the wires could become quite hot during use. End caps with leads attached were then placed over the ends of the rod making contact to the resistive wire, usually a nickel chromium alloy.

The value of wirewound resistors remain fairly flat with increasing temperature, but change greatly with frequency. It is also difficult to precisely control the value of the resistor during construction so they must be measured and sorted after they are built.

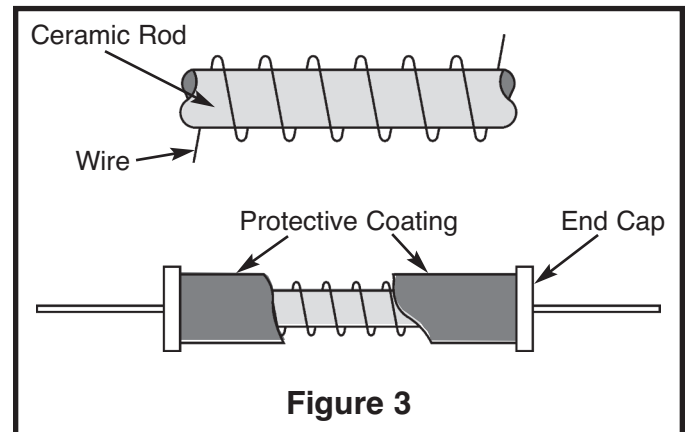

Figure 3

THE CARBON COMPOSITION RESISTOR

By grinding carbon into a fine powder and mixing it with resin, a material can be made with different resistive values. Conductive leads are placed on each end of a cylinder of this material and the unit is then heated or cured in an oven. The body of the resistor is then painted with an insulating paint to prevent it from shorting if touched by another component. The finished resistors are then measured and sorted by value (Figure 4). If these resistors are overloaded by a circuit, their resistance will permanently decrease. It is important that the power rating of the carbon composition resistor is not exceeded.

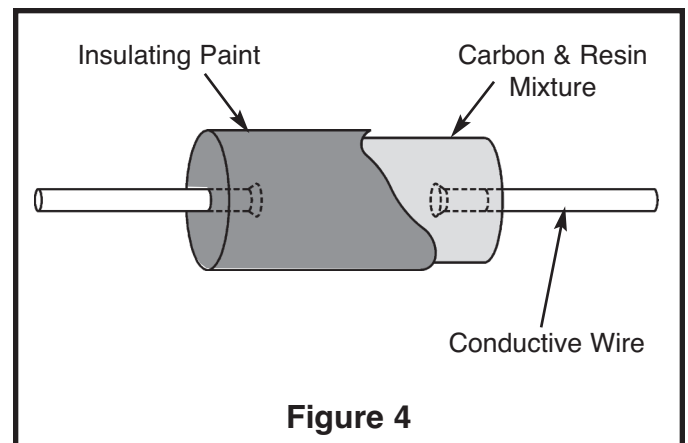
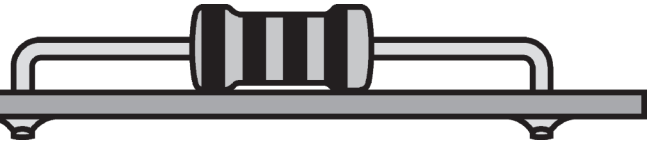

Figure 4

RESISTORS



CARBON FILM RESISTORS

Carbon film resistors are made by depositing a very thin layer of carbon on a ceramic rod. The resistor is then protected by a flameproof jacket since this type of resistor will burn if overloaded sufficiently. Carbon film resistors produce less electrical noise than carbon composition and their values are constant at high frequencies. You can substitute a carbon film resistor for most carbon composition resistors if the power ratings are carefully observed. The construction of carbon film resistors require temperatures in excess of 1,000°C.

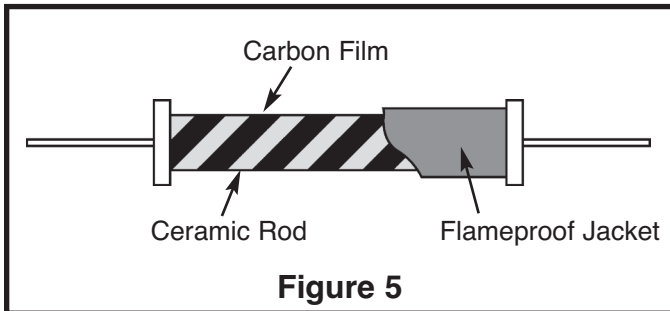

METAL OXIDE RESISTORS

Metal oxide resistors are also constructed in a similar manner as the carbon film resistor with the exception that the film is made of tin chloride at temperatures as high as 5,000°C. Metal oxide resistors are covered with epoxy or some similar plastic coating. These resistors are more costly than other types and therefore are only used when circuit constraints make them necessary.

METAL FILM RESISTORS

Metal film resistors are also made by depositing a film of metal (usually nickel alloy) onto a ceramic rod. These resistors are very stable with temperature and frequency, but cost more than the carbon film or carbon composition types. In some instances, these resistors are cased in a ceramic tube instead of the usual plastic or epoxy coating.

THE VARIABLE RESISTOR

When a resistor is constructed so its value can be adjusted, it is called a variable resistor. Figure 6 shows the basic elements present in all variable resistors. First a resistive material is deposited on a non-conducting base. Next, stationary contacts are connected to each end of the resistive material. Finally, a moving contact or wiper is constructed to move along the resistive material and tap off the desired resistance. There are many methods for constructing variable resistors, but they all contain these three basic principles.

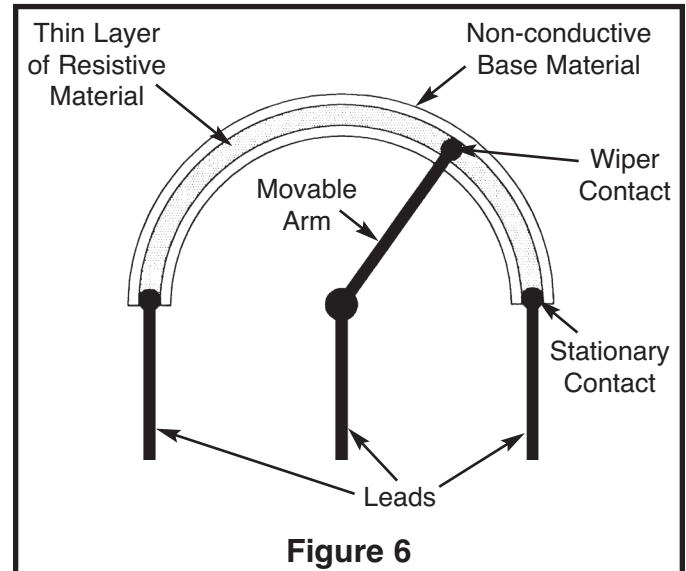

RESISTORS

RESISTOR VALUES AND MARKINGS

The unit of measure for resistance is the ohm, which is represented by the Greek letter Ω . Before technology improved the process of manufacturing resistors, they were first made and then sorted. By sorting the values into groups that represented a 5% change in value, (resistor values are 10% apart), certain preferred values became the standard for the electronics industry. Table 1 shows the standard values for 5% resistors.

10	11	12	13	15	16	18	20
22	24	27	30	33	36	39	43
47	51	56	62	68	75	82	91

Table 1

Resistors are marked by using different colored rings around their body (see Figure 7). The first ring represents the first digit of the resistor's value. The second ring represents the second digit of the resistor's value. The third ring tells you the power of ten to multiply by. The final and fourth ring represents the tolerance. For example, gold is for 5% resistors and silver for 10% resistors. This means the value of the resistor is guaranteed to be within 5% or 10% of the value marked. The colors in Table 2 are used to represent the numbers from 0 to 9.

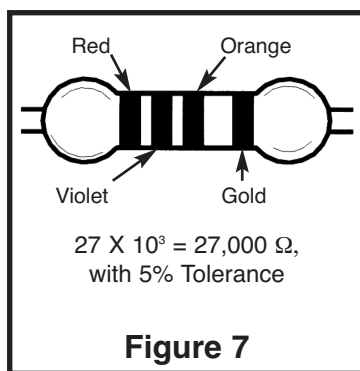

Figure 7

COLOR	VALUE
Black	0
Brown	1
Red	2
Orange	3
Yellow	4
Green	5
Blue	6
Violet	7
Gray	8
White	9

Table 2

BAND 1 1st Digit		BAND 2 2nd Digit		Multiplier		Resistance Tolerance	
Color	Digit	Color	Digit	Color	Multiplier	Color	Tolerance
Black	0	Black	0	Black	1	Silver	+10%
Brown	1	Brown	1	Brown	10	Gold	+5%
Red	2	Red	2	Red	100	Brown	+1%
Orange	3	Orange	3	Orange	1,000	Red	+2%
Yellow	4	Yellow	4	Yellow	10,000	Orange	+3%
Green	5	Green	5	Green	100,000	Green	+5%
Blue	6	Blue	6	Blue	1,000,000	Blue	+25%
Violet	7	Violet	7	Silver	0.01	Violet	+1%
Gray	8	Gray	8	Gold	0.1		
White	9	White	9				

Note: If the third ring is gold, you multiply the first two digits by 0.1 and if it is silver, by 0.01. This system can identify values from 0.1Ω to as high as 91×10^9 , or 91,000,000,000 Ω . The amount of power each resistor can handle is usually proportional to the size of the resistor. Figure 8 shows the actual size and power capacity of normal carbon film resistors, and the symbols used to represent resistors on schematics.

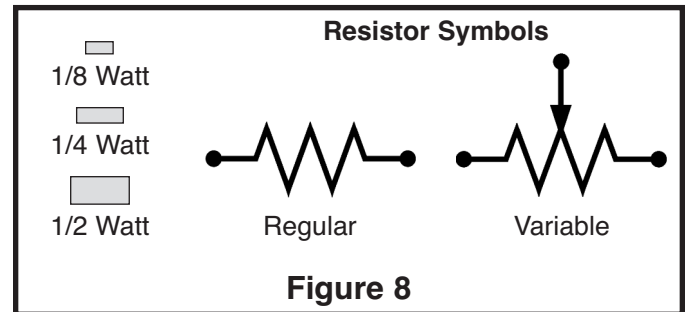
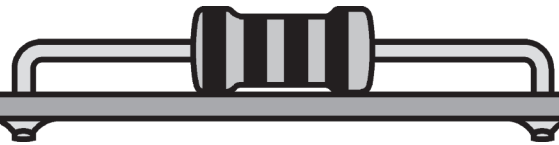

Figure 8

RESISTORS



SELF TEST

THEORY

Circle the letter that best fits the description.

- A flow of electrons through a material:
a) Voltage c) Current
b) Resistance d) Conductance
- The pressure that pushes electrons through a material:
a) Voltage c) Conduction
b) Current d) Resistance
- A material that has very high resistance to electron flow:
a) Conductor c) Resistor
b) Semiconductor d) Insulator
- A material that allows electrons to flow easily:
a) Conductor c) Resistor
b) Semiconductor d) Insulator
- A material that produces electrical friction and restricts the flow of electrons:
a) Conductor c) Resistor
b) Semiconductor d) Insulator
- A resistor that is made by wrapping a wire around a ceramic rod:
a) Carbon Film c) Thermistor
b) Carbon Composition d) Wirewound
- A resistor made by heating powder and resin in an oven:
a) Carbon Film c) Thermistor
b) Carbon Composition d) Wirewound
- A resistor made by depositing a very thin layer of resistive material on a ceramic rod:
a) Carbon Film c) Thermistor
b) Carbon Composition d) Wirewound
- One of the preferred values for a 5% resistor:
a) 4000Ω c) 77Ω
b) 560Ω d) 395Ω
- The amount of wattage a resistor can handle is determined by:
a) Value c) Current
b) Voltage d) Size

PRACTICE

Open the bag marked "resistors" and fill in the table below.

Color 1	Color 2	Color 3	Color 4	Value	Percent	Wattage

EXTRA CREDIT

Using a razor blade or sharp knife, scrape away the paint on the body of one resistor and determine the type of construction used to make it. Try and determine all of the materials used including the metals used to make the leads.

CAPACITORS

CAPACITORS, *What do they do?*

Capacitors are components that can store electrical pressure (Voltage) for long periods of time. When a capacitor has a difference in voltage (Electrical Pressure) between its two leads it is said to be charged. A capacitor is charged by forcing a one way (DC) current to flow through it for a short period of time. It can be discharged by letting an opposite direction current flow out of the capacitor. Consider for a moment the analogy of a water pipe that has a rubber diaphragm sealing off each side of the pipe as shown in Figure 9.

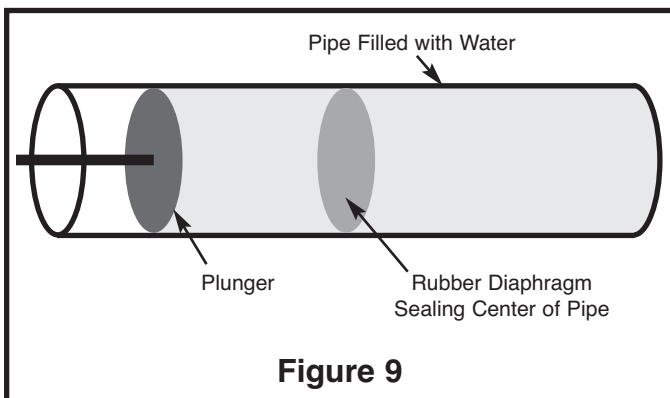

If the pipe had a plunger on one end, as shown in Figure 9, and the plunger was pushed toward the diaphragm, the water in the pipe would force the rubber to stretch out until the force of the rubber pushing back on the water was equal to the force of the plunger. You could say the pipe is charged and ready to push the plunger back. In fact, if the plunger is released it will move back to its original position. The pipe will then be discharged or with no charge on the diaphragm.

Capacitors act the same as the pipe in Figure 9. When a voltage (Electrical Pressure) is placed on one lead with respect to the other lead, electrons are forced to “pile up” on one of the capacitor’s plates until the voltage pushing back is equal to the voltage applied. The capacitor is then charged to the voltage. If the two leads of that capacitor are shorted, it would have the same effect as letting the plunger in Figure 9 move freely. The capacitor would rapidly discharge and the voltage across the two leads would become zero (No Charge).

What would happen if the plunger in Figure 9 was wiggled in and out many times each second? The water in the pipe would be pushed by the diaphragm then sucked back by the diaphragm. Since the movement of the water (Current) is back and forth (Alternating) it is called an Alternating Current or AC. The capacitor will therefore pass an alternating current with little resistance. When the push on the plunger was only toward the diaphragm, the water on the other end of the diaphragm moved just enough to charge the pipe (transient current). Just as the pipe blocked a direct push, a capacitor blocks direct current (DC). An example of alternating current is the 60 cycle (60 wiggles each second) current produced when you plug something into a wall outlet.

SUMMARY: A capacitor stores electrical energy when charged by a DC source. It can pass alternating current (AC), but blocks direct current (DC) except for a very short charging current, called transient current.

CAPACITORS

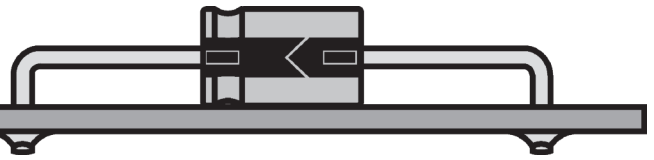

CAPACITORS, *How are they made?*

There are many different types of capacitors used in electronics. Each type is made from different materials and with different methods. Capacitors are also made to handle different amounts of electrical pressure or voltage. Each capacitor is marked to show the maximum voltage that it can withstand without breaking down. All capacitors contain the same fundamental parts, which consist of two or more conductive plates separated by a nonconductive material. The insulating material between the plates is called the dielectric. The basic elements necessary to build a capacitor are shown in Figure 10.

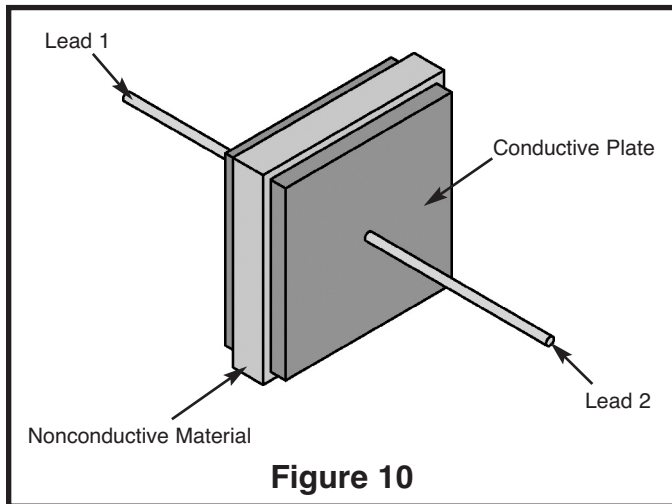

Figure 10

pressure (low capacitance, but high working voltage). By making the pipe larger and keeping the stiff rubber we can achieve a device that holds a large amount of water and withstands a high amount of pressure (high capacitance, high working voltage, large size). These three types of water pipes are illustrated in Figure 12. The pipes follow the rule that the capacity to hold water, (Capacitance) multiplied by the amount of pressure they can take (Voltage) determines the size of the pipe. In electronics the CV product determines the capacitor size.

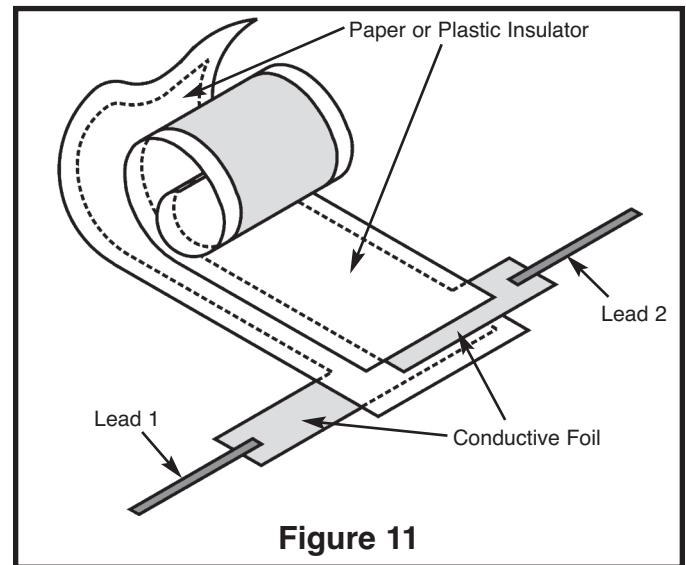

Figure 11

THE METAL FOIL CAPACITOR

Perhaps the most common form of capacitor is constructed by tightly winding two foil metal plates that are separated by sheets of paper or plastic as shown in Figure 11. By picking the correct insulating material the value of capacitance can be increased greatly, but the maximum working voltage is usually lowered. For this reason, capacitors are normally identified by the type of material used as the insulator or dielectric. Consider the water pipe with the rubber diaphragm in the center of the pipe. The diaphragm is equivalent to the dielectric in a capacitor. If the rubber is made very soft, it will stretch out and hold a large amount of water, but it will break easily (large capacitance, but low working voltage). If the rubber is made very stiff, it will not stretch far, but will be able to withstand higher

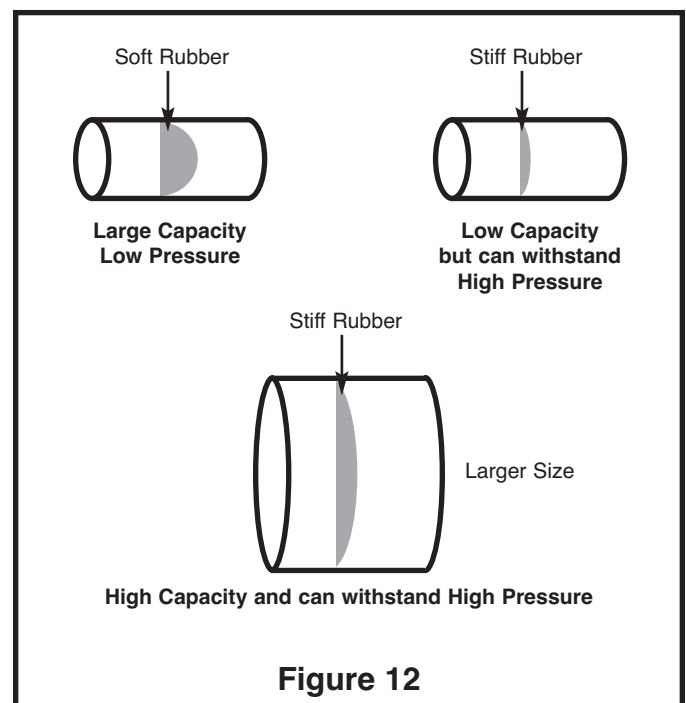

Figure 12

CAPACITORS

DIELECTRIC CONSTANT, *What is it?*

The dielectric (rubber diaphragm in the water pipe analogy) in a capacitor is the material that can withstand electrical pressure (Voltage) without appreciable conduction (Current). When a voltage is applied to a capacitor, energy in the form of an electric charge is held by the dielectric. In the rubber diaphragm analogy the rubber would stretch out and hold the water back. The energy was stored in the rubber. When the plunger is released the rubber would release this energy and push the plunger back toward its original position. If there was no energy lost in the rubber diaphragm, all the energy would be recovered and the plunger would return to its original position. The only perfect dielectric for a capacitor in which no conduction occurs and from which all the stored energy may be recovered is a perfect vacuum. The *DIELECTRIC CONSTANT* (K) is the ratio by which the capacitance is increased when another dielectric replaces a vacuum between two plates. Table 3 shows the Dielectric Constant of various materials.

Air, at normal pressure	1	Mica	7.5
Alcohol, ethyl (grain)	25	Paper, manila	1.5
Beeswax	1.86	Paraffin wax	2.25
Castor Oil	4.67	Porcelain	4.4
Glass flint density 4.5	10	Quartz	2
Glycerine	56	Water, distilled	81

Table 3

THE VARIABLE CAPACITOR

To make a variable capacitor, one set of stationary aluminum plates are mounted to a frame with a small space between each plate. Another set of plates are mounted to a movable shaft and designed to fit into the space of the fixed plates without touching them. The insulator or dielectric in this type of variable capacitor is air. When the movable plates are completely inside the fixed plates, the device is at minimum capacitance. The shape of the plates can be designed to achieve the proper amount of capacitance versus rotation for different applications. An additional screw is added to squeeze two insulated metal plates together (Trimmer) and thus set the minimum amount of capacitance.

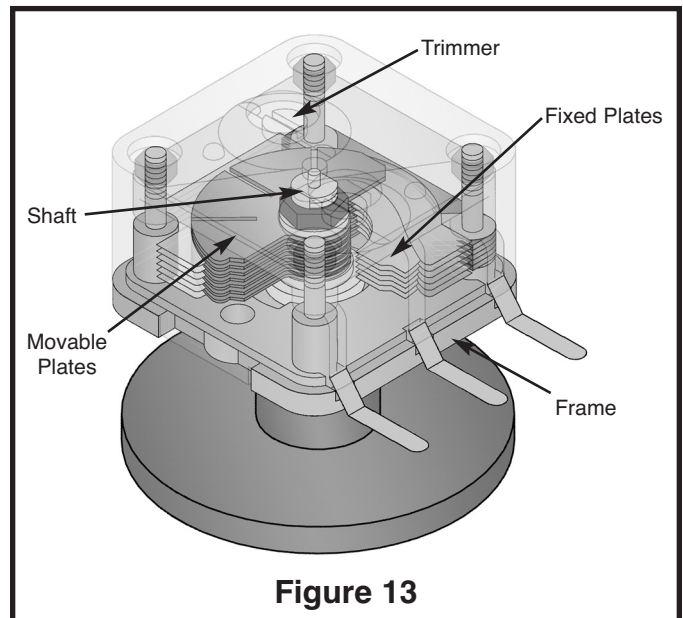

CAPACITORS

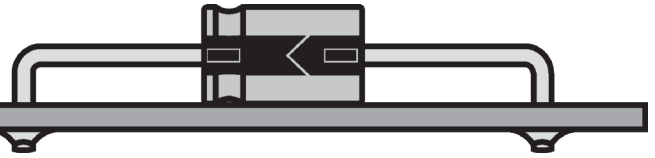

CAPACITANCE, How is it calculated?

The amount of charge a capacitor can hold (capacitance) is measured in Farads. In practice, one farad is a very large amount of capacitance, making the most common term used micro-farad or one millionth of a farad. There are three factors that determine the capacitance that exist between two conductive plates:

1. The bigger the plates are (Surface Area), the higher the capacitance. Capacitance (C) is directly proportional to Area (A).
2. The larger the distance is between the two plates, the smaller the amount of capacitance. Capacitance (C) is indirectly proportional to distance (d).
3. The larger the value of the dielectric constant, the more capacitance (Dielectric constant is equivalent to softness of the rubber in our pipe analogy). The capacitance (C) is directly proportional to the Dielectric Constant (K) of the insulating material. From the above factors, the formula for capacitance in Farads becomes:

$$C = 0.244K \frac{A(N-1)}{d} \text{ Picofarads} *$$

C = Capacitance in Picofarads (Farad x 10⁻¹²)

K = Dielectric Constant

A = Area of one Plate in square inches

N = Number of Plates

d = Distance between plates in inches

Example Calculation for Capacitor shown in Figure 14.

$C = 2.24 \times (1 \times 1)(2 - 1) / (.01) = 224 \text{ Picofarads}$ or 0.000224 Microfarads.

* If A and d are in centimeters change 0.224 to 0.0885.

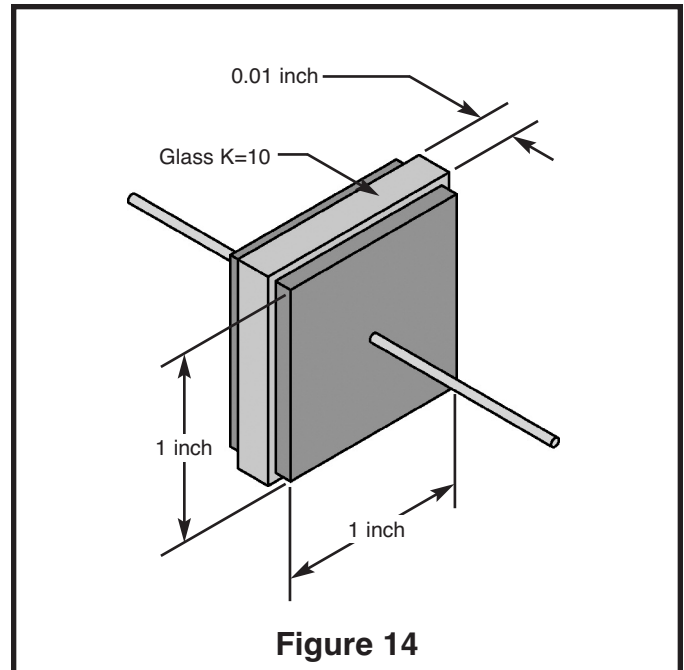

Figure 14

CAPACITOR VALUES AND MARKINGS

The older styles of capacitors were marked with colored dots or rings similar to resistors. In recent years, the advances in technology has made it easier to print the value, working voltage, tolerance, and temperature characteristics on the body of the capacitors. Certain capacitors use a dielectric that requires markings to insure one lead is always kept at a higher voltage than the other lead. Figure 15 shows typical markings found on different types of capacitors. Table 4 gives the standard values used and the different methods for marking these values.

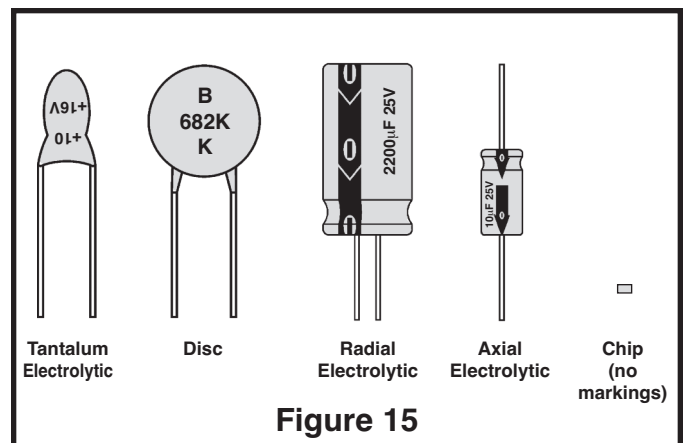

Figure 15

CAPACITORS

Voltage 1	Code 2	Cap. Value 3	Typical Markings		Tolerance (%) 6	Markings 7
			4	5		
4	0G	100pF	100pF	101	±5%	J
5.5	0L	.001μF	.001	102	±10%	K
6.3	0J	.015μF	.015	152	±20%	M
10	1A	.002μF	.002	202	-10% +30%	Q
16	1C	.0022μF	.0022	222	-10% +50%	T
25	1E	.003μF	.003	302	-20% +80%	Z
35	1V	.033μF	.033	333	SPECIAL	A
50	1H	.047μF	.047	473		
63	1J	.05μF	.05	R05	Temperature Markings	
80	1K	.068μF	.068	R068		
100	2A	.1μF	.1	104	NP0 {<10ppm / °C}	
110	2Q	.15μF	.15	154	N100 {<100ppm / °C}	
125	2B	.2μF	.2	204	N220 {<220ppm / °C}	
160	2C	2.2μF	2.2	2R2	N820 {<820ppm / °C}	
180	2Z	22μF	22	22	Y5F	
200	2D	100μF	100	100	Y5T	
220	2P	220μF	220	220	Y5V	
250	2E	470μF	470	470	X5F	
315	2F	1000μF	1000	1000	Z5U	

Capacitor markings vary greatly from one manufacturer to another as the above table shows. Voltages may be marked directly (200V) or coded (2D). The value of capacitance may be marked directly on the part as shown in columns 4 and 5 (note that .001μF and 1000μF have the same marking, but the difference in size makes the value obvious). The number 102 may also be used to represent 1000 (10+2 zeros). In some instances the

manufacturer may use an R to represent the decimal point. The tolerance is usually printed directly on the capacitors. When it is omitted, the standard tolerance is assumed to be +80% to -20% for electrolytics. Capacitance change with temperature is coded in parts per million per degree C, {N220 = 220/1,000,000 or .022%}, or by a temperature graph. See manufacturers specifications for complete details.

CAPACITOR SYMBOLS

Figure 16 shows the schematic symbols used to represent capacitors. The + symbol indicates that the capacitor is polarized and the lead marked with the + sign must always have a *higher* voltage than the other lead. The curved plate, plate with sides, and minus sign also indicate the capacitor is polarized and these leads must always be at a *lower* voltage than the other lead. The arrow crossing through the capacitor indicates of capacitance is variable.

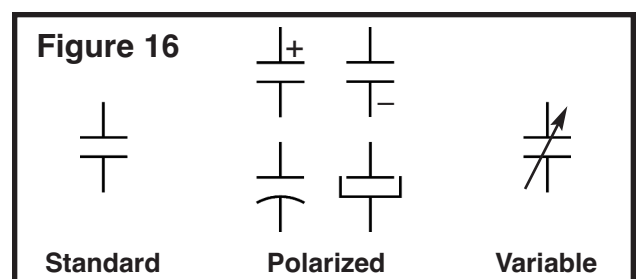

CAPACITORS

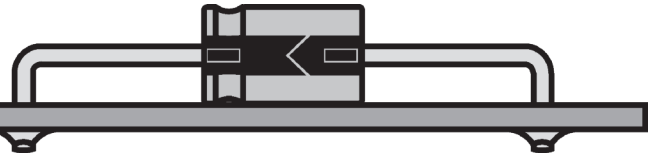

SELF TEST

THEORY

Circle the letter that best fits the description.

- A flow of electrons in one direction:
 - AC Voltage
 - Direct Voltage
 - Alternating Current
 - Direct Current
- When two conductive plates are moved closer together Capacitance will:
 - Increase
 - Decrease
 - Stay the Same
 - Vary Downwards
- The name given to the material between a capacitor's plates:
 - Air
 - Dielectric
 - Conductor
 - Insulator
- Electrons flowing in and out of a wire:
 - AC Voltage
 - Direct Voltage
 - Alternating Current
 - Direct Current
- If the size of the conductive plates is increased, capacitance will:
 - Increase
 - Decrease
 - Stay the Same
 - Vary Downwards
- A capacitor will block:
 - AC Voltage
 - Direct Voltage
 - Alternating Current
 - Direct Current
- When electrons are forced onto one plate of a capacitor:
 - Polarization
 - Discharging
 - Storage
 - Charging
- A capacitor lead that is marked with a + must always be:
 - Grounded
 - At highest voltage
 - At higher voltage than the other lead
 - b & c
- A small disc capacitor marked 100 has a value of:
 - 100 μ F
 - .00001F
 - 100pF
 - 100F
- A large electrolytic capacitor marked 100 has a value of:
 - 100 μ F
 - .00001F
 - 100pF
 - 100F
- If a dielectric is changed from air to distilled water the capacitance will:
 - remain the same
 - increase 81 times
 - decrease
 - drop in half
- A dielectric that stores energy with no loss:
 - Does not exist
 - Air
 - Pure Glass
 - A perfect vacuum

PRACTICE

Open the bag marked "capacitors" and fill in the table below.

Type	Capacitance Value	Working Voltage	Polarized (Y/N)	Other Markings

Table 4

EXTRA CREDIT

What happens to the total capacitance if you connect two capacitors as shown in Figure 17. Hint, use water pipe analogy and try to calculate equivalent if one water pipe.

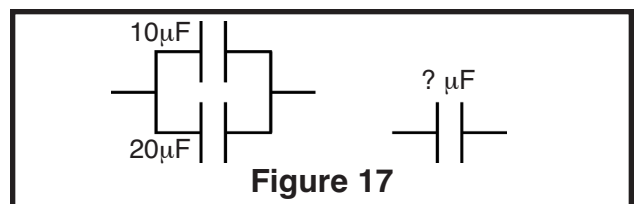
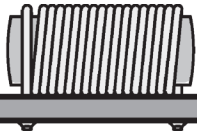

Figure 17



INDUCTORS

INDUCTORS, *What do they do?*

The electronic component known as the inductor is best described as electrical momentum. In our water pipe analogy the inductor would be equivalent to a very long hose that is wrapped around itself many times (see Figure 18). If the hose is very long it will contain many gallons of water. When pressure is applied to one end of the hose, the thousands of gallons of water would not start to move instantly. It would take time to get the water moving due to inertia (a body at rest wants to stay at rest). After a while the water would start to move and pick up speed. The speed would increase until the friction of the hose applied to the amount of pressure being applied to the water. If you try to instantly stop the water from moving by holding the plunger, the momentum (a body in motion wants to stay in motion) of the water would cause a large negative pressure (Suction) that would pull the plunger from your hands.

Since Inductors are made by coiling a wire, they are often called Coils. In practice the names Inductor and Coil are used interchangeably. From the above analogy, it is obvious that a coiled hose will pass Direct Current (DC), since the water flow increases to equal the resistance in the coiled hose after an elapsed period of time. If the pressure on the plunger is alternated (pushed, then pulled) fast enough, the water in the coil will never start moving and the Alternating Current (AC) will be blocked. The nature of a Coil in electronics follows the same principles as the coiled hose analogy. A coil of wire will pass DC and block AC. Recall that the nature of a Capacitor blocked DC and passed AC, the exact opposite of a coil. Because of this, the Capacitor and Inductor are often called Dual Components. Table 5 compares the properties of capacitors and inductors.

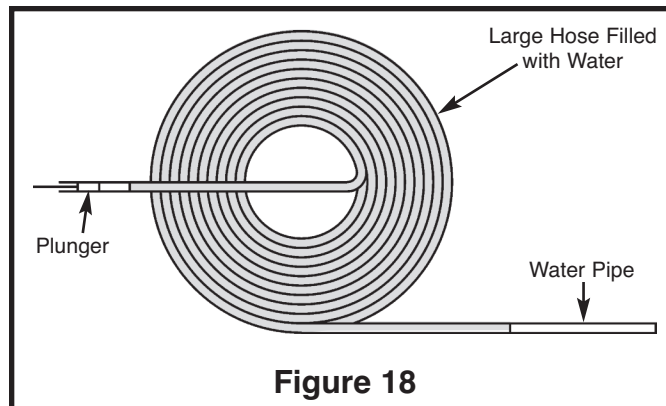
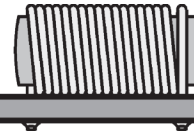

Figure 18

Capacitor	Inductor
Blocks Direct Current	Blocks Alternating Current
Passes Alternating Current	Passes Direct Current
Voltage in Capacitor cannot change instantly	Current in an Inductor cannot change instantly
Quick Voltage change produces large Current	Quick Current change produces large Voltage
Stores Energy in Electric Field	Stores Energy in Magnetic Field
Current leads Voltage	Voltage leads Current

Table 5

INDUCTORS



INDUCTORS, *How are they made?*

In order to understand how inductors are made, we have to change our water pipe analogy slightly to include the effect of magnetic fields. Consider two pipes filled with water and small magnets attached to the walls of the pipes with rubber bands as shown in Figure 19. The moving magnets, due to the original current, pull the magnets in the second pipe and force a small current to flow in the same direction as the original current. When the rubber bands are fully stretched, the induced current will stop, even though the initial DC current is still flowing. If the original current is an AC current however, it will induce a continuous AC current in the second pipe because the magnets will move back and forth, pulling the magnets in the second pipe back and forth.

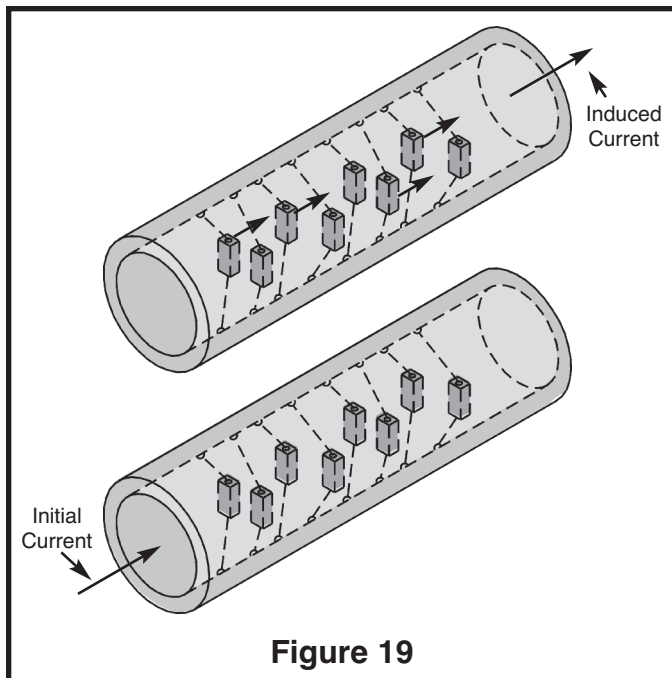

Figure 19

Consider the two coiled pipes shown in Figure 20. When the pipe is stretched out (increased length) as in coil 1, the adjacent turns have little affect on each other. In coil 2 (decreased length) the magnets in each turn of the pipe are linking and the amount of “apparent mass” in the pipe seems to increase. In an inductor, pushing the coiled wire closer together causes the inductance of the coil to also increase, and stretching the coil out will lower the inductance of the coil. In other words, the inductance of a coil is indirectly proportional to its length. If the diameter of

the coil is increased, it will take more hose to form a loop, and the amount of water will therefore increase. More water means a larger “apparent mass”. Inductance will also increase in a coil if the cross sectional area increases. Inductance is directly proportional to area.

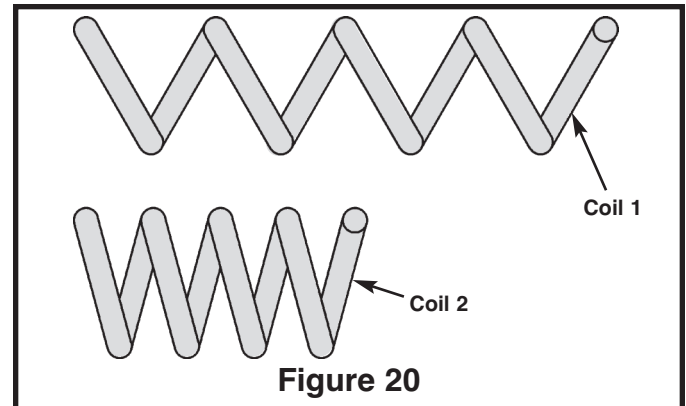

Figure 20

Consider the affect of adding more turns to coiled pipe. The amount of material to push (mass) is increased and the amount of linkage is increased due to more magnets available. This causes the “apparent mass” to increase at a greater rate than would be expected. When making an inductor, the actual inductance is directly proportional to the square of the number of turns.

The final factor to consider when making a coil is the core material at the center of the coil. If our pipe wrapped around a material that contained many magnets, they would also link to the magnets in the pipe. This would increase the “apparent mass” of the water in the pipe. The tiny magnets in the core would rotate as shown in Figure 21 and force the water to keep moving in the same direction. Placing an iron core at the center of an inductor will directly increase the inductance by an amount equal to the permeability of the core material.

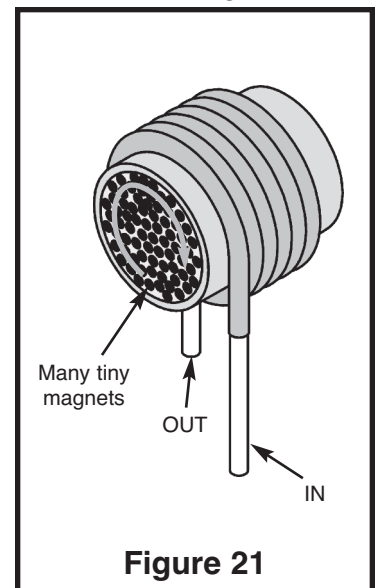
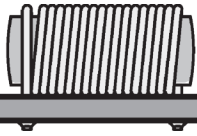

Figure 21



INDUCTORS

INDUCTANCE, *How is it calculated?*

Reviewing how coils are made will show the following:

1. Inductance of a coil is indirectly proportional to the length of the coil.
2. Inductance is directly proportional to the cross sectional area.
3. Inductance is proportional to the square of the number of turns.
4. Inductance is directly proportional to the permeability of the core material.

From the above information the formula for inductance of a simple iron core would be:

$$L = \frac{N^2 \mu A}{10l}$$

TRANSFORMERS, *How are they made?*

Placing different coils on the same iron core as shown in Figure 22 produces the electronic component known as the Transformer. If a DC current is forced through the center coil, the other two coils will only produce a current when the original current is changing. Once the DC current reaches a constant value, the other two coils will “unlink” and produce no flowing current if loaded. If the generator voltage is continuously changing as in Figure 22, it will produce a current that changes with time. This changing current in the center coil will produce similar currents in both of the end coils. Since the bottom coil has twice the number of turns (twice the magnetic linkage), the voltage across this coil will be twice the generator voltage. The power in an electronic device is equal to the voltage across the device times the current through the device ($P=VI$). If the voltage doubles on the bottom winding, then the current must become 1/2 due to the law of conservation of power (Power cannot be created or destroyed, but can be transformed from one state to another). Since the bottom coil is wound in the same direction as the generator coil, the voltage across the coil (top wire to bottom wire) will be the same polarity as the generator voltage. The top coil is wound in the opposite direction

Where:

L = Inductance in microhenrys

N = Number of turns

μ = Permeability of core material

A = Cross-sectional area of coil, in square inches

l = Length of coil in inches

This formula is good only for solid core coils with length greater than diameter.

forcing the core magnet rotation (Called flux by the Pros) to push the current in the opposite direction and produce a voltage of the opposite polarity. Since the number of turns in the top coil are the same as the generator coil, the voltage and current (Power that can be taken from the coil) will also be equal. This ability to transform AC voltages and AC currents influenced early experimenters to call this device a Transformer.

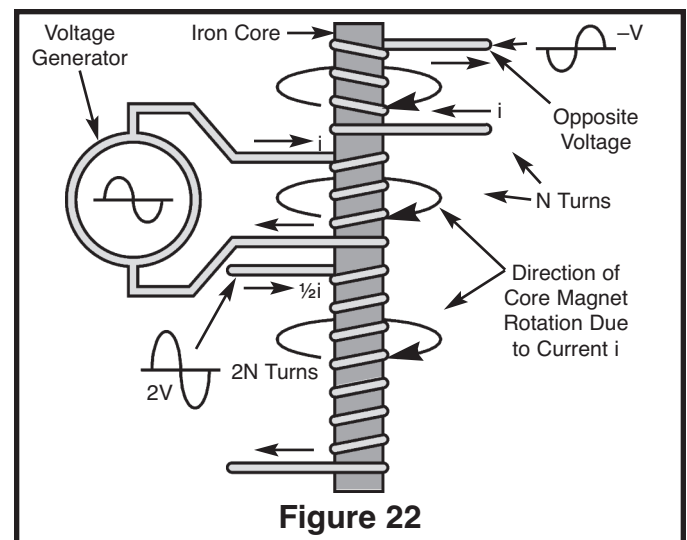
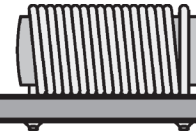

Figure 22

INDUCTORS



TWO MORE LAWS ABOUT INDUCTORS

Faraday's Law states that any time a conductor moves through a magnetic field (Figure 23) a voltage is generated. Because of this principle, it is possible to attach a magnet (or coil) to a rotating device and produce large amounts of electrical power (the Hoover Dam for example).

Lenz' Law states that the induced currents in a conductor passing through a magnetic field will produce a magnetic field that will oppose the motion between the magnet and the conductor. To produce a large amount of electrical power, a large mechanical force is required (conservation of power).

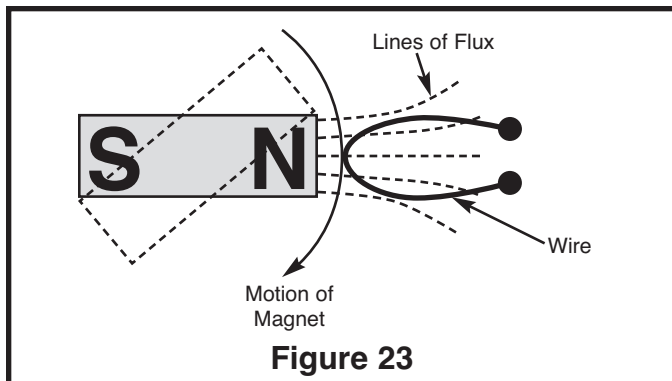

Figure 23

INDUCTANCE SYMBOLS AND MARKINGS

Most inductors are custom made to meet the requirements of the purchaser. They are marked to match the specification of the buyer and therefore carry no standard markings. The schematic symbols for coils and transformers are shown in Figure 24. These symbols are the most commonly used to represent fixed coils, variable coils, and transformers.

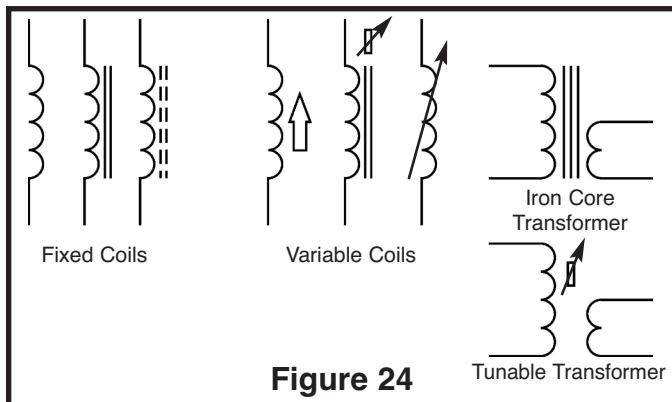

Figure 24

THE Q FACTOR IN COILS $\frac{X_L}{r}$

The Q (figure of merit) of a coil is the ratio of the inductive reactance to the internal series resistance of the coil. Since the reactance and resistance can both change with frequency, Q must be measured at the desired frequency. Anything that will raise the inductance without raising the series resistance will increase the Q of the coil; for example, using an iron core. Lowering the series resistance without lowering the inductance will also raise the Q, more turns of larger wire for example. Q is important when the inductor is used in a resonant circuit to block or select desired frequencies. The higher the Q, the tighter the selection of frequencies become.

SUMMARY

The Inductor prevents current from making any sudden changes by producing large opposing voltages. Magnetic coupling can be used to transform voltages and currents, but power must remain the same. Coils and transformers can be used to select frequencies.

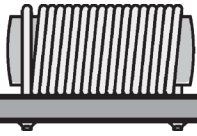

INDUCTORS

SELF TEST

THEORY

Circle the letter that best fits the description.

- The inductor is best described as:
a) Induced Voltage c) Electrical Storage Device
b) Long Wire d) Electrical Momentum
- When wires in a coil are moved closer together, the inductance will:
a) Increase c) Stay the Same
b) Decrease
- Another word used to represent an inductor:
a) Wire c) Transformer
b) Coil d) Conductor
- If the diameter of a coil is increased, the inductance will:
a) Increase c) Stay the Same
b) Decrease
- If the number of turns in a coil is decreased, the inductance of that coil will:
a) Increase c) Stay the Same
b) Decrease
- An inductor will block:
a) Alternating Voltage c) Alternating Current
b) Direct Voltage d) Direct Current
- When an iron core is placed into the center of a coil, the inductance will:
a) Increase c) Stay the Same
b) Decrease
- If voltage in a transformer is stepped down, the current will:
a) Increase c) Must Stay the Same
b) Decrease
- When a conductor is moved through a magnetic field:
a) Power is created c) Magnetic field is reduced
b) A voltage is generated on the wire. d) a & c
- The Q factor of a coil is equal to:
a) Wire quality c) Ratio of inductance to resistance
b) Ratio of reactance to resistance
- If windings on a straight rod are in the same direction, the induced voltage will have:
a) Same amplitude c) Same polarity
b) Different amplitude d) Different polarity
- An inductor stores energy in its:
a) Electric field c) Core
b) Magnetic field d) Wires

PRACTICE

Using the coil supplied, answer the following questions.

Is the coil wound on an iron form? Yes ____ No ____

What prevents the wire from shorting? _____

How many turns are on the coil? _____

Example: Using a length of 0.1", a radius of 0.02", permeability of 14 for the iron core, and 56 turns, calculate the inductance of the coil and record here: _____

EXTRA CREDIT

What happens to the total inductance if you connect two coils as shown in Figure 25. Hint, remember the coiled hose analogy and try to calculate equivalent if one coiled hose.

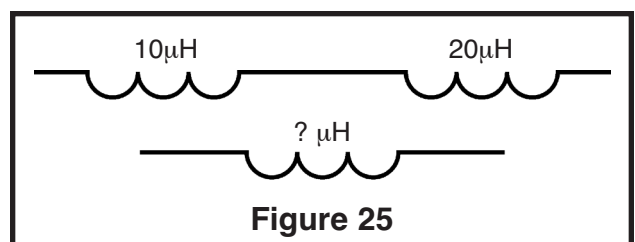
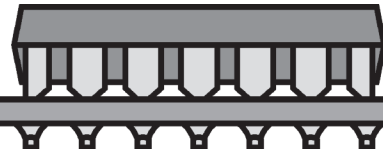

Figure 25

SEMICONDUCTORS



THE DIODE, *what is it?*

The diode can be compared to the check valve shown in Figure 26. The basic function of a check valve is to allow water to flow in only one direction. Once the force of the spring is exceeded, the plate moves away from the stop allowing water to pass through the pipe. A flow of water in the opposite direction is blocked by the solid stop and plate. If it took a pressure of 0.7lb to exceed the spring force, the flow of water versus pressure might look like Figure 27. In electronics, this curve would represent the typical silicon diode if pounds per square inch equaled volts and gallons per minute equaled amperes. Of course, the amount of current that flows through the diode must be limited or the device could be damaged. Just as too much water through the check valve could destroy the plate (shorted diode). If the diode is made of Gallium Arsenide, it would take approximately twice the voltage to produce a flow of current (spring in Figure 26 is twice as strong). The energy level required to "turn on" a Gallium Arsenide diode is so high, that light is generated when current starts to flow. These diodes are called "Light Emitting Diodes", or simply LEDs.

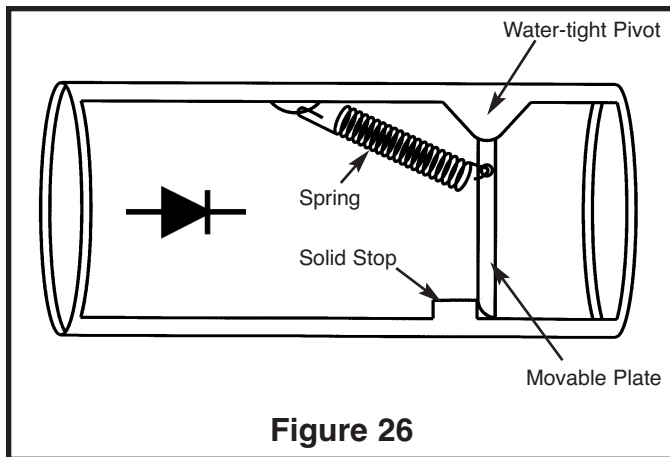

Figure 26

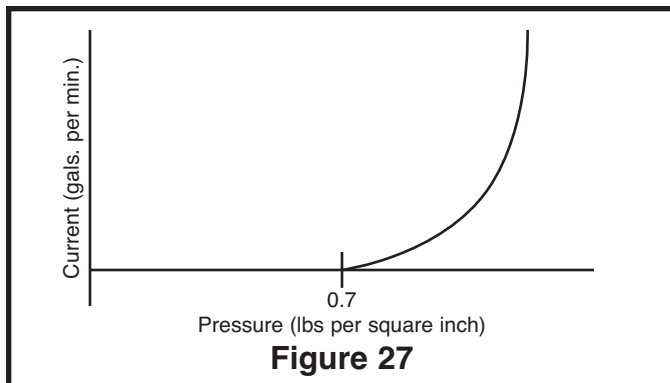

Figure 27

THE TRANSISTOR, *what is it?*

The transistor is best described as a device that uses a small amount of current to control a large amount of current (Current Amplifier). Consider a device fabricated as shown in Figure 28. A small amount of "Base Current" pushes on the L_1 portion of the lever arm forcing check valve D_1 to open, even though it is "reverse biased" (pressure is in direction to keep check valve shut). Keep in mind the base current would not start to flow until the check valve D_2 allowed current to flow (0.7lb). If the current ratio through D_1 and Base was equal to the lever arm advantage, then $I_1 / I_b = L_1 / L_2$. Call this ratio Beta (β) and let $L_1 = 1$ inch and $L_2 = 0.01$ inch. Then $\beta = 100$ and I_1 will be 100 times I_b . Since both currents must pass through D_2 , $I_2 = I_1 + I_b$. These same principles apply to a silicon NPN transistor. I_1 becomes collector current (I_C), and I_2 would be emitter current (I_E). $\beta = I_C / I_B$ and $I_E = I_B + I_C$.

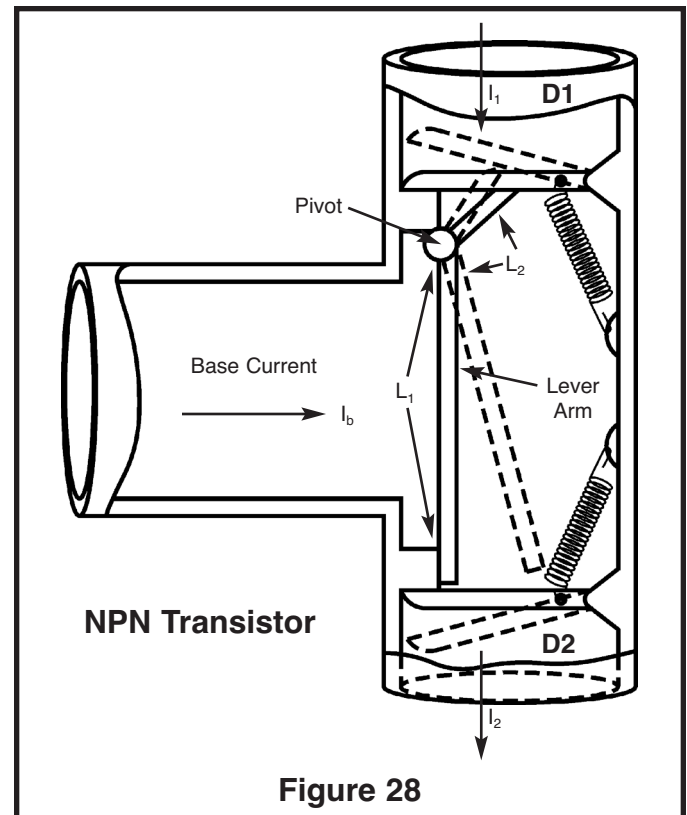
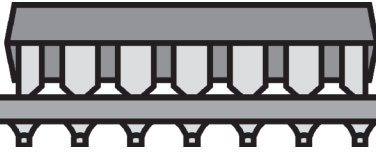

Figure 28



SEMICONDUCTORS

THE PNP TRANSISTOR

Figure 29 represents the water pipe equivalent of a PNP transistor. The emitter releases current that splits into two paths. The base current “forces open” the collector check valve which collects all the current except the small amount that goes into the base. The direction of current in the PNP transistor is opposite that of the NPN transistor. Because of these differences, the emitter of the PNP is usually referenced to the power supply voltage and the emitter of the NPN is usually referenced to ground or zero voltage. In both transistors, the current amplification factor (I_c/I_b) is called Beta (β).

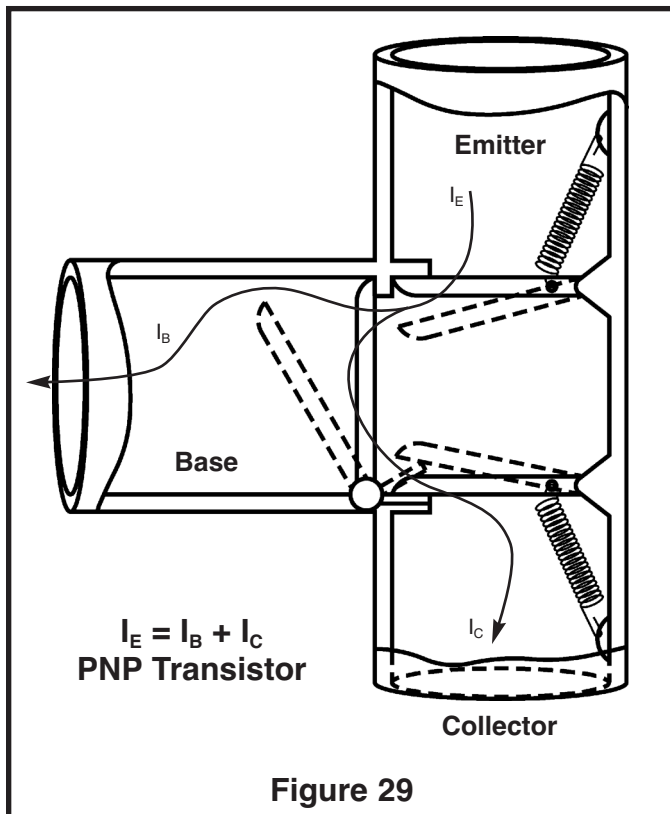

THE FIELD EFFECT TRANSISTOR

In Figure 30 the center of a small section of a pipe is made of thin, flexible rubber and that rubber is surrounded by water from a third pipe called the gate. When pressure is applied to the gate, the rubber pinches off the current from the source to the drain. No current flows from gate to drain or source. This device uses a change in gate pressure to control the current flowing from source to drain.

Since there are no check valves, the current can flow in either direction. In other words, this device acts like a variable resistor. The Field Effect Transistor (FET) also controls current between source and drain by “pinching off” the path between them. The level of voltage on the gate controls the amount of current that will flow. Since no DC current flows in or out of the gate (only momentarily a small amount will flow to adjust to new pressures as in a capacitor), the power used by the gate is very close to zero. Remember, power equals voltage times current, and if the current is zero, the power is zero. This is why FETs are used in the probes of test equipment. They will not disturb the circuit being tested by removing power during a measurement. When a second gate section is added (pipe and rubber) between the source and drain it is called a Dual Gate FET. In our water pipe analogy of the FET transistor, the rubber must be very thin and flexible in order to “pinch off” the current from the source to the drain. This means it could be easily damaged by a small “spike” of high pressure. The same is true of an electronic FET. A high voltage “spike” (Static Electricity) can destroy the gate and ruin the FET. To protect the FET, they are sometimes packaged with metal rings shorting their leads, and a fourth lead may be added to the metal case containing the transistor.

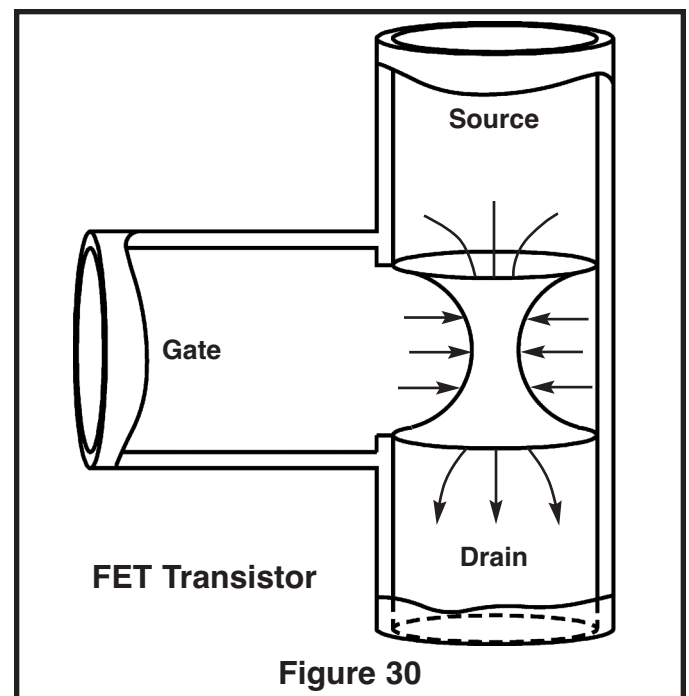

SEMICONDUCTORS

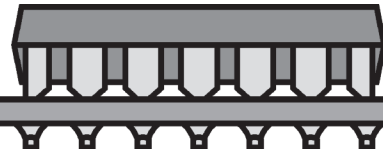

THE INTEGRATED CIRCUIT

If the water pipe analogies of the resistor, diode, transistor, and very small capacitors could be etched into a single block of steel you would have the equivalent of the Integrated Circuit in Electronics. Figure 31 represents such a device. This block of steel would have to be very large to include all the mechanical parts needed. In electronics, the actual size of a diode or transistor is extremely small. In fact, millions can be fabricated

on a piece of silicon no larger than the head of a pin. Photographic reduction techniques are used to generate the masking needed to isolate each part. These masks are then stepped and repeated in order to make many separate integrated circuits at the same time on a single substrate. Using mass production techniques, these circuits are manufactured, packaged, and sold at prices much lower than the equivalent discrete circuit would cost.

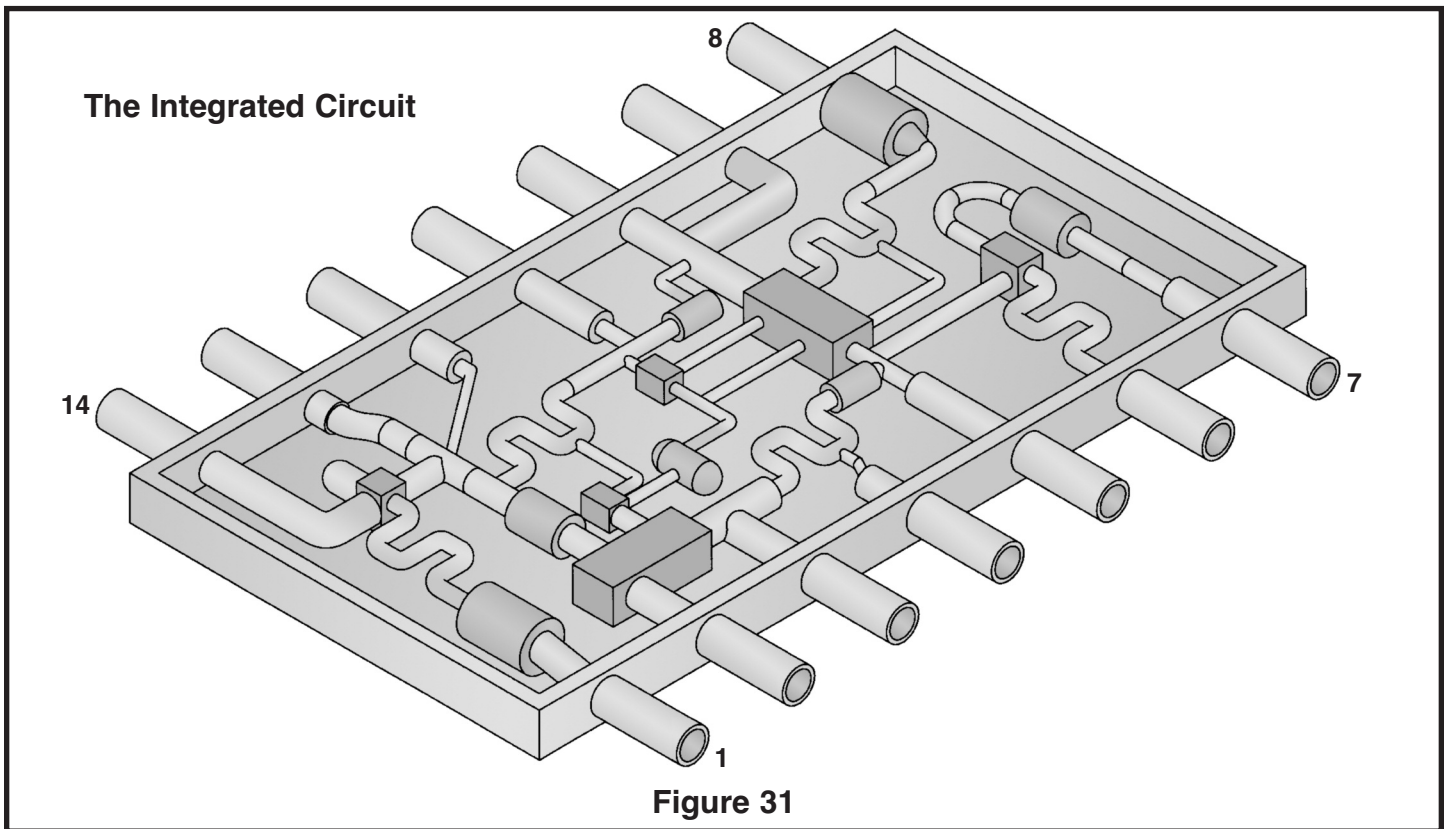

SEMICONDUCTOR SYMBOLS

Figure 32 shows the common symbols used in electronics to represent the basic components. Integrated Circuits are usually drawn as blocks with leads or as a triangle for operational amplifiers. The Zener diode (voltage reference diode) is used in the reverse direction at the point of breakdown.

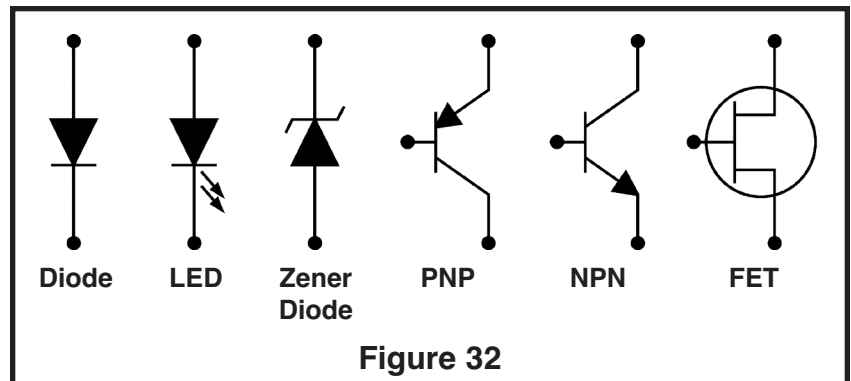

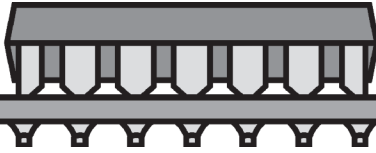

SEMICONDUCTORS

SELF TEST

THEORY

Circle the letter that best fits the description.

- The diode is best described as:
 - Switch
 - Check Valve
 - Electrical Storage Device
 - Electrical Momentum
- A silicon diode begins to conduct current at approximately:
 - 7 volts
 - 0.7 volts
 - 0.7 lb.
 - 7 lbs.
- NPN transistors have:
 - 2 leads
 - 3 leads
 - 2 diodes
 - b & c
- NPN and PNP transistors are used to:
 - Create Power
 - Change Resistance
 - Control Current
 - Control Capacitance
- The ratio of collector current to base current in a transistor is called:
 - Beta (β)
 - Amplification
 - Current Control
 - FET
- A diode made of Gallium Arsenide is called:
 - Zener Diode
 - Power Diode
 - LED
 - Detector Diode
- A Field Effect Transistor controls Source to Drain current by:
 - Diode Conduction
 - Base Current
 - Base Voltage
 - Gate Diode
- A Zener Diode is used as:
 - Voltage Reference
 - Current Reference
 - Resistance Control
 - b & c
- An Integrated Circuit contains:
 - Diodes and Resistors
 - Transistors and Small Capacitors
 - Inductors
 - a & b
- If the arrow in the symbol for a transistor points toward the base lead, the transistor is a:
 - NPN Transistor
 - PNP Transistor
 - FET Transistor

PRACTICE

Open the Semiconductor bag and answer the following questions.

- How many of the devices are diodes? _____
- How many of the devices look like transistors? _____
- How many integrated circuits are included? _____
- Was a Light Emitting Diode included? _____
- How are the diodes marked to show which end current will not go into? _____

EXTRA CREDIT

Connect the LED (light emitting diode) to a 9 volt battery (not provided) as shown in Figure 33. Why is the resistor necessary? If the LED does not light up reverse the battery leads. Why does the LED only light when connected a certain way?

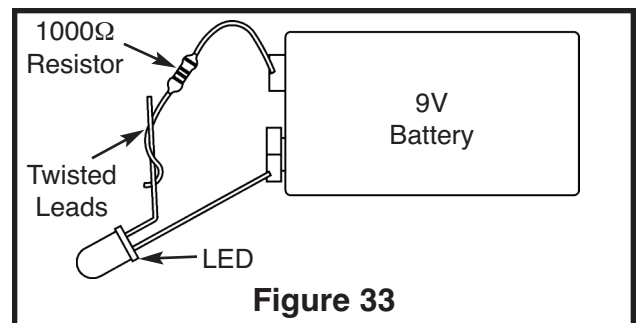

MECHANICAL PARTS

PRINTED CIRCUIT BOARDS, *What are they?*

A printed circuit is a conductive pattern glued to one or both sides of an insulating material. Holes are punched or drilled through the conductor and board to allow the interconnection of electronic parts. In the case of a double sided board, the holes are plated to provide a connection between the conductors on both sides of the board. This method provides considerable space savings over hand wiring and allows for automated insertion and soldering of parts. A more uniform product is produced because wiring errors are eliminated. The insulating material thickness may vary from 0.015" to 0.500". The most widely used base material is NEMA-XXXX paper base phenolic. Copper is the most common conductive material glued to the base. The common thicknesses of the copper foil are 0.0014" (1 oz./sq. ft.) and 0.0028" (2 oz./sq. ft.).

For single sided boards, the copper is laminated to the board and then screened and etched away. Double sided boards use a plating process and conductive ink to achieve the desired layout.

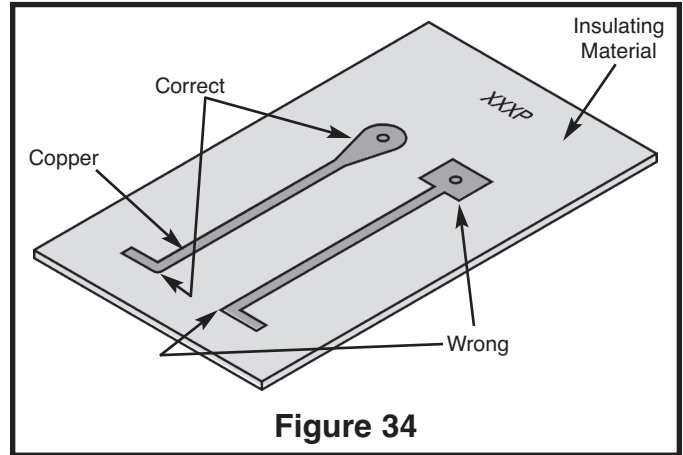

Figure 34

Note: The PC board included with this kit is only a sample and will not be assembled.

DESIGN RULES

After a the breadboard has been tested, there are some design rules used to layout the printed circuit board. A few of these basic rules are listed here:

1. Diameter of punched holes should not be less than $\frac{2}{3}$ the board thickness.
2. Distance between punched holes or between holes and board edge should not be less than the board thickness.
3. Holes should not exceed more than 0.020" of the diameter of the wire to be inserted in the hole (machine insertion may require more, but leads should be "clinched").
4. Conductor widths should be large enough to carry current peaks. A width of one tenth of an inch (1 oz./sq. ft. copper) will increase in temperature 10°C at a DC current of 5A.
5. Conductor spacing must be capable of withstanding applied voltages. If a voltage difference of 500 volts exists between two copper runs, they must be separated by at least 0.03" to prevent breakdown.
6. Avoid the use of sharp corners when laying out copper (see Figure 34). Sharp corners produce high electric fields that can lower breakdown. Sharp corners will also make it easier for copper to peel from the board.
7. Heavy parts must be mounted to prevent board damage if the unit is dropped.
8. The printed circuit board must be fastened to prevent leads from touching the case or any other object mounted near the board.
9. Mounting hardware must be designed to prevent board stress (warping or excessive torque).

MECHANICAL PARTS

THE TOP LEGEND

The component side of a printed circuit board should always have a drawing showing the placement of the parts and their schematic marking (R1, R2, etc.). This drawing is called the *Top Legend*. When a board needs to be repaired, the schematic becomes the “road map” and the top legend becomes the “address” on the part. Figure 35 shows the correlation between the Schematic and the Top Legend.

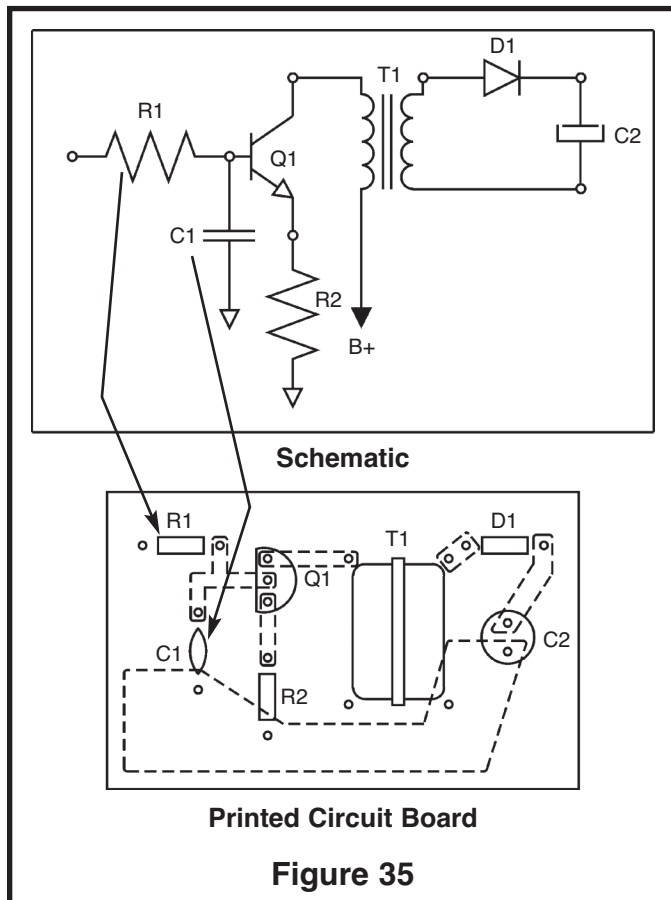

SOLDER, *The Electronic Glue*

Different parts have been discussed. A printed circuit board to interconnect these parts has been discussed. Now it's time to talk about the “Electronic Glue” called Solder. Soldering wire is composed of Tin and Copper with a rosin or acid core. Acid core solder should never be used on electronic boards since the acid will damage the components. Acid core solder is mainly used to attach metals (copper water pipes for example). When tin and copper are mixed, the melting point of the mixture is lower than the melting point of either tin or copper. The point at which the melting point is the lowest is when the mixture equals 99.3% tin and 0.7% copper. This is called the eutectic (*ū tek'tik*) point of the mixture. The most common flux placed at the center of this hollow wire alloy is Rosin based. Removing the flux from the board requires a chemical that can dissolve rosin. In recent years many water soluble fluxes have been developed. These fluxes can be removed by washing the boards in water.

After the parts are placed in the holes on the printed circuit board, their leads should be trimmed and bent. A good mechanical connection will improve the soldering capability of the parts by forcing the part and copper on the board to rise to the same temperature. Positioning the soldering iron correctly and using the right amount of heat are crucial to a good solder job. Solder practicing is highly recommended (Elenco® Solder Practice Kit Model SP-1A).

MECHANICAL PARTS

OTHER MECHANICAL PARTS

There are many other mechanical parts used by manufacturers of electronic equipment. Most of them fall into the category of switching or connecting circuits. In Figure 36, five of the six parts shown are used to switch or connect signals to the printed circuit board. Only the spacer falls into a different category, called mounting. The switch is used to redirect current or voltage from one circuit to another. The wire nut is used to hold two twisted wires together and insulate them (prevent them from being bare and exposed) at the same time. The PC board male and female connectors are used to attach wires from controls or other circuits to the printed circuit board. The Earphone Jack is used to bring a signal from the printed circuit board to an earphone. The spacer holds the printed circuit board away from the case to prevent leads from shorting to the case.

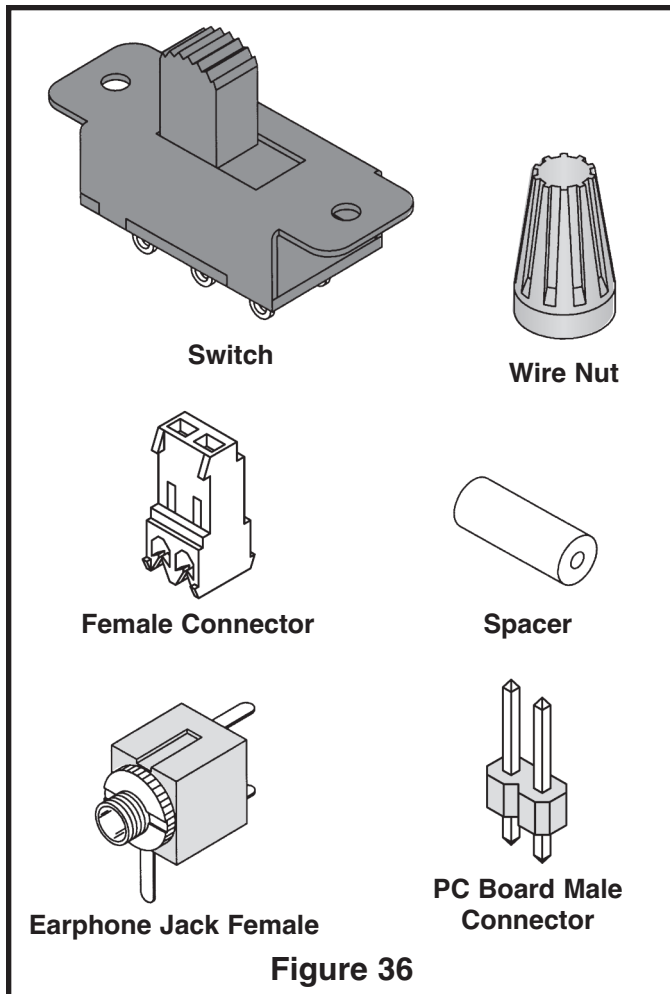

MOUNTING HARDWARE

There are many different methods for mounting printed circuit boards. The simplest method is using machine screws and spacers. Figure 37 shows some of the common screw heads used by electronic manufacturers. The oval head screw in Figure 37 has a tapered end that will cut into the metal and make a thread for the body of the screw. The self-threading screw eliminates the need for a nut and lockwasher but can produce metal fragments that must be removed to prevent shorts from occurring.

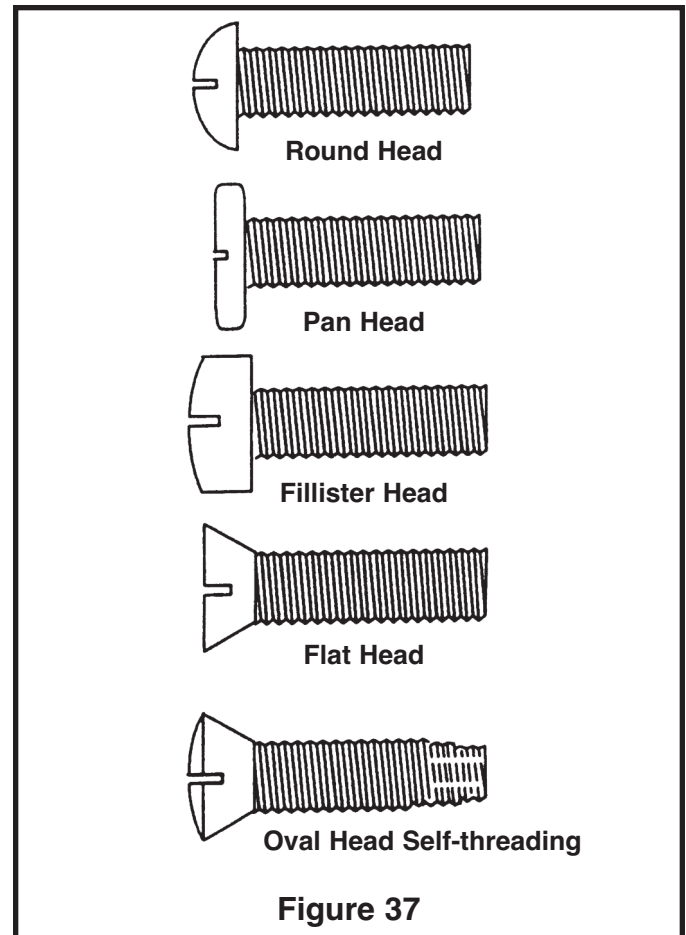

MECHANICAL PARTS

SELF TEST

THEORY

Circle the letter that best fits the description.

- Copper patterns on a Printed Circuit Board should always be:
 - As thin as possible
 - Sharp and square
 - Rounded
 - On one side only
- The distance between conductors on a printed circuit should be large enough to:
 - Etch easily
 - Solder across
 - Clean
 - Prevent voltage breakdown
- The top legend shows:
 - Copper path
 - Part placement
 - Schematic
 - Hole numbers
- The schematic shows:
 - Part placement
 - Copper path
 - Hole sizes
 - Electrical connections
- The material the copper is glued to on a printed circuit board is called a:
 - Conductor
 - Semiconductor
 - Resistor
 - Insulator
- Solder with the lowest melting point has a ratio of tin to lead of:
 - 63/37
 - 60/40
 - 40/60
 - 37/63
- Solder made for electronic parts has a:
 - Hollow Core
 - Rosin Core
 - Acid Core
 - No Core
- The type of screw NOT mentioned in this course is:
 - Sheet Metal
 - Machine
 - Round Head
 - Self-threading

PRACTICE

Open the Mechanical bag and answer the following questions.

How many of the following parts were in the mechanical bag?

Switches _____ Male PC Board Connectors _____

Earphone Jacks _____ Wire Nuts _____ Spacers _____ Round Head Screws _____

Pan Head Screws _____ Flat Head Screws _____

Self-threading Screws _____ Sheet Metal Screws _____

EXTRA CREDIT

What is the function of the mechanical part included in the bag that was not mentioned in the instruction sheets?

ANSWERS TO QUIZZES

PAGE 5

1.c 2.a 3.d 4.a 5.c 6.d 7.b 8.a 9.b 10.d

COLOR 1	COLOR 2	COLOR 3	COLOR 4	VALUE	PERCENT	WATTAGE
Brown	Black	Black	Gold	10Ω	5%	1/2 Watt
Brown	Green	Brown	Red	150Ω	5%	1/4 Watt
Brown	Black	Red	Gold	1,000Ω	5%	1/4 Watt
Brown	Red	Red	Gold	1,200Ω	5%	1/2 Watt
Red	Yellow	Red	Gold	2,700Ω	5%	1/2 Watt
Brown	Black	Orange	Gold	10,000Ω	5%	1/2 Watt
Blue	Red	Orange	Gold	62,000Ω	5%	1/4 Watt
Orange	Orange	Green	Gold	3,300,000Ω	5%	1/2 Watt
Brown	Black	Blue	Gold	10,000,000Ω	5%	1/2 Watt
Brown	Green	Blue	Gold	15,000,000Ω	5%	1/4 Watt

PAGE 11

1.d 2.a 3.b 4.c 5.a 6.d 7.d 8.c 9.c 10.a 11.b 12.d

Type	Capacitance Value	Working Voltage	Polarized (Y/N)	Other Markings
Disc	33pF		N	—
Mylar	0.001μF	100 volts	N	K
Electrolytic	10μF	25 volts	Y	—
Electrolytic	220μF	25 volts	Y	—
Electrolytic	10μF	50 volts	Y	—
Electrolytic	10μF	35 volts	Y	—
Electrolytic	220μF	16 volts	Y	—

Answer to Extra Credit: 30μF

PAGE 16

1.d 2.a 3.b 4.a 5.b 6.c 7.a 8.a 9.b 10.b 11.c 12.b

Practice: No - the coil is not wound on a metal core. Enamel coating on wire prevents it from shorting. There are 2 turns on the coil. Calculated inductance is 64 microhenrys.

Answer to Extra Credit: 30μH

PAGE 20

1.b 2.b 3.d 4.c 5.a 6.c 7.d 8.a 9.d 10.b

Practice: 3 Diodes 3 Transistors 1 Integrated Circuit Yes, 1 LED

A line is painted around the end that blocks current. LED uses flat side to indicate blocking end.

Answer to Extra Credit: Resistor is necessary to limit current and prevent LED from damage. LEDs are diodes that only pass current in one direction.

PAGE 24







1.c 2.d 3.b 4.d 5.d 6.a 7.b 8.a

Practice: 1 Switch 1 Female 1 Male 1 Earphone Jack 1 Wire Nut 2 Spacers 1 Round 9 Pan 1 Flat Head 2 Self Threading 2 Sheet Metal

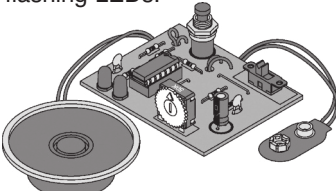
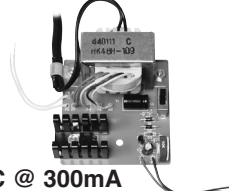
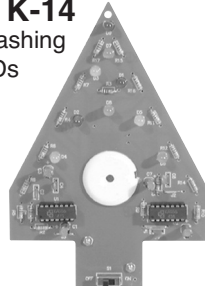
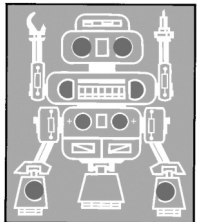
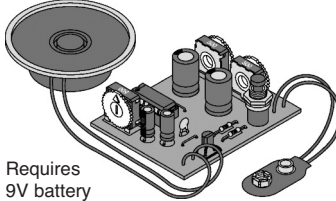
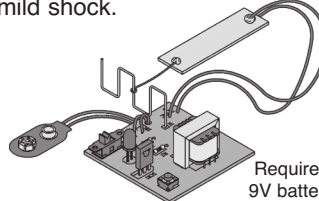
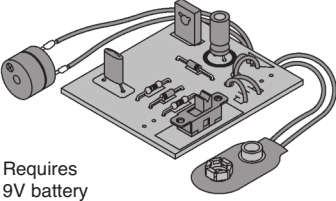
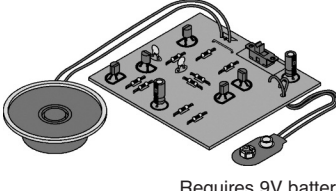
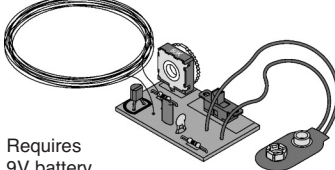
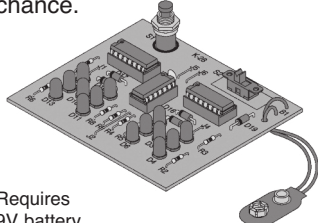
Answer to Extra Credit: Part in bag that was not mentioned included one strain relief to hold a line cord. Parts included for further study were 2 thicknesses of rosin core solder and 1 printed circuit board.

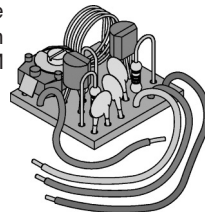
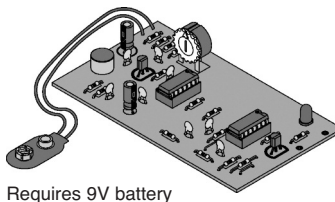
EDUCATION KITS

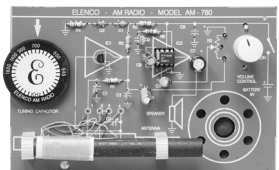
Complete with PC Board and Instruction Book

<p>Space War Gun K-10</p> <p>Rapid fire or single shot with 2 flashing LEDs.</p>  <p>Requires 9V battery</p>	<p>0-15V Power Supply K-11</p> <p>A low-cost way to supply voltage to electronic games, etc.</p>  <p>0-15VDC @ 300mA</p>	<p>Christmas Tree K-14</p> <p>Produces flashing colored LEDs and three popular Christmas melodies.</p>  <p>Requires 9V battery</p>	<p>LED Robot Blinker K-17</p> <p>You'll have fun displaying the PC board robot. Learn about free-running oscillators.</p>  <p>Requires 9V battery</p>
<p>Digital Bird K-19</p> <p>You probably have never heard a bird sing this way before.</p>  <p>Requires 9V battery</p>	<p>Nerve Tester K-20</p> <p>Test your ability to remain calm. Indicates failure by a lit LED or mild shock.</p>  <p>Requires 9V battery</p>	<p>Yap Box K-22A</p> <p>This kit is a hit at parties. Makes 6 exciting sounds.</p>  <p>Requires 9V battery</p>	<p>Burglar Alarm K-23</p> <p>Alarm for your car, house, room, or closet.</p>  <p>Requires 9V battery</p>
<p>Whooper Alarm K-24</p> <p>Can be used as a sounder or siren.</p>  <p>Requires 9V battery</p>	<p>Metal Detector K-26</p> <p>Find new money and old treasure. Get started in this fascinating hobby.</p>  <p>Requires 9V battery</p>	<p>Pocket Dice K-28</p> <p>To be used with any game of chance.</p>  <p>Requires 9V battery</p>	<p>FM Microphone AK-710/K-30</p> <p>Learn about microphones, audio amplifiers, and RF oscillators. Range up to 100 feet.</p>  <p>Requires 2 "AA" batteries</p> <p>Training course incl.</p>
<p>Telephone Bug K-35</p> <p>Our bug is only the size of a quarter, yet transmits both sides of a telephone conversation to any FM radio.</p>  <p>No batteries required!</p>	<p>Sound Activated Switch K-36</p> <p>Clap and the light comes on . . . clap again and it goes off.</p>  <p>Requires 9V battery</p>	<p>Lie Detector K-44</p> <p>The sound will tell if you are lying. The more you lie, the louder the sound gets.</p>  <p>Requires 9V battery</p>	<p>Motion Detector AK-510</p> <p>Use as a sentry, message minder, burglar alarm, or a room detector.</p>  <p>Requires 9V battery</p>
<p>Two IC AM Radio AM-780K</p> <p>New design - easy-to-build, complete radio on a single PC board. Requires 9V battery.</p> 	<p>Transistor Tester DT-100K</p> <p>Test in-circuit transistors and diodes.</p>  <p>Requires 9V battery</p>	<p>0-15VDC Variable Voltage DC Power Supply Kit XP-15K</p> <p>Ideal for students, technicians, and hobbyists. Great for breadboarding.</p> 	<p>Auto-scan FM Radio Kit FM-88K</p> <p>Unique design - two-IC FM receiver with training course.</p>  <p>Requires 9V battery</p>

WEISHI INNOVATION

Modern Window Building, Block A,
10A1, Huaqiang North, Futian
District, Shenzhen City, China

+86 010 82611102

Website:<https://weishielectronics.com/>

e-mai:chenweixin@zhongdianbaina.com